



Description

JMT N-channel MOSFET

Features

- $V_{DS}=60V$, $I_D=0.2A$
 $R_{DS(ON)}<2.1\Omega$ @ $V_{GS} = 10V$
 $R_{DS(ON)}<2.7\Omega$ @ $V_{GS} = 4.5V$
- Advanced Trench Technology
- Excellent $R_{DS(ON)}$ and Low Gate Charge
- Lead free product is acquired
- ESD Protected: 2KV

Application

- Battery Operated Systems
- Direct logic-level Interface: TTL/CMOS
- Solid-State Relays

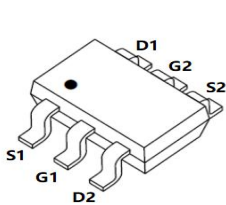

SOT-363-6L top view

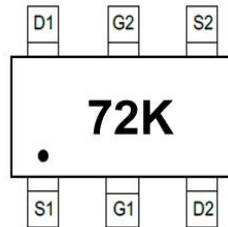

Marking and pin Assignment

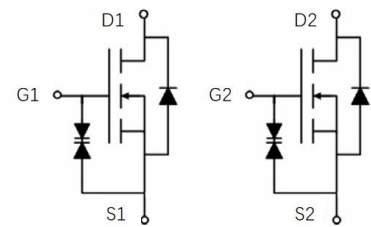

Schematic diagram

Package Marking and Ordering Information

Device Marking	Device	OUTLINE	Device Package	Reel Size	Reel (PCS)	Per Carton (PCS)
72K	JMTLB2N7002KDS	TAPING	SOT-363-6L	7inch	3000	120000

Absolute Maximum Ratings ($T_A=25^\circ C$ unless otherwise specified)

Symbol	Parameter	Max.	Units
V_{DSS}	Drain-Source Voltage	60	V
V_{GSS}	Gate-Source Voltage	± 20	V
I_D	Continuous Drain Current	$T_A = 25^\circ C$	0.2
		$T_A = 100^\circ C$	0.13
I_{DM}	Pulsed Drain Current ^{note1}	0.8	A
P_D	Power Dissipation	$T_A = 25^\circ C$	0.38
$R_{\theta JA}$	Thermal Resistance, Junction to Ambient	328	$^\circ C/W$
T_J, T_{STG}	Operating and Storage Temperature Range	-55 to +150	$^\circ C$



Electrical Characteristics (T_J=25°C unless otherwise specified)

Symbol	Parameter	Test Condition	Min.	Typ.	Max.	Units
Off Characteristic						
V _{(BR)DSS}	Drain-Source Breakdown Voltage	V _{GS} =0V, I _D = 10μA	60	-	-	V
I _{DSS}	Zero Gate Voltage Drain Current	V _{DS} =60V, V _{GS} = 0V,	-	-	1	μA
I _{GSS}	Gate to Body Leakage Current	V _{DS} =0V, V _{GS} = ±20V	-	-	±10	uA
On Characteristics						
V _{GS(th)}	Gate Threshold Voltage	V _{DS} = V _{GS} , I _D = 250μA	1	-	2.5	V
R _{DS(on)}	Static Drain-Source on-Resistance <small>note2</small>	V _{GS} =10V, I _D =0.3A	-	1.6	2.1	Ω
		V _{GS} =4.5V, I _D =0.2A	-	1.9	2.7	
Dynamic Characteristics						
C _{iss}	Input Capacitance	V _{DS} = 25V, V _{GS} = 0V, f = 1.0MHz	-	28	-	pF
C _{oss}	Output Capacitance		-	11	-	pF
C _{rss}	Reverse Transfer Capacitance		-	4	-	pF
Q _g	Total Gate Charge	V _{DS} = 10V, I _D = 0.3A, V _{GS} = 4.5V	-	1.7	-	nC
Q _{gs}	Gate-Source Charge		-	0.3	-	nC
Q _{gd}	Gate-Drain("Miller") Charge		-	0.6	-	nC
Switching Characteristics						
t _{d(on)}	Turn-on Delay Time	V _{DD} = 10V, I _D =0.2A, R _{GEN} = 10Ω, V _{GS} =10V,	-	2	-	ns
t _r	Turn-on Rise Time		-	15	-	ns
t _{d(off)}	Turn-off Delay Time		-	7	-	ns
t _f	Turn-off Fall Time		-	20	-	ns
Drain-Source Diode Characteristics and Maximum Ratings						
I _S	Maximum Continuous Drain to Source Diode Forward Current		-	-	0.2	A
I _{SM}	Maximum Pulsed Drain to Source Diode Forward Current		-	-	0.8	A
V _{SD}	Drain to Source Diode Forward Voltage	V _{GS} = 0V, I _S =0.2A	-	-	1.2	V

Notes:1. Repetitive Rating: Pulse Width Limited by Maximum Junction Temperature

2. Pulse Test: Pulse Width≤300μs, Duty Cycle≤2%



Typical Performance Characteristics

Figure 1: Output Characteristics

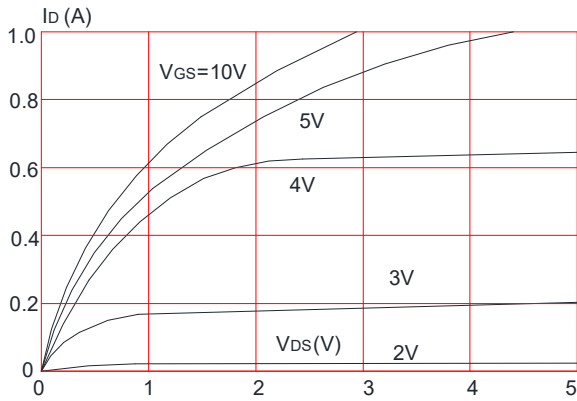

Figure 2: Typical Transfer Characteristics

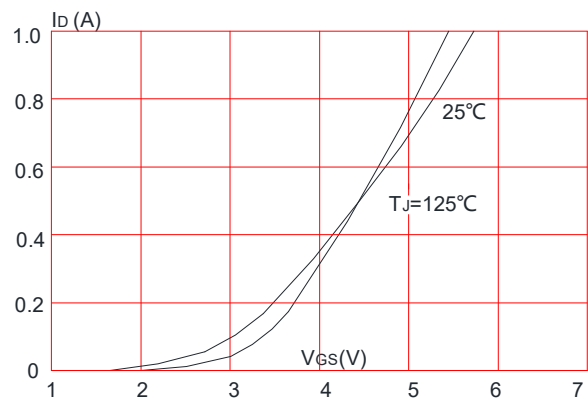

Figure 3: On-resistance vs. Drain Current

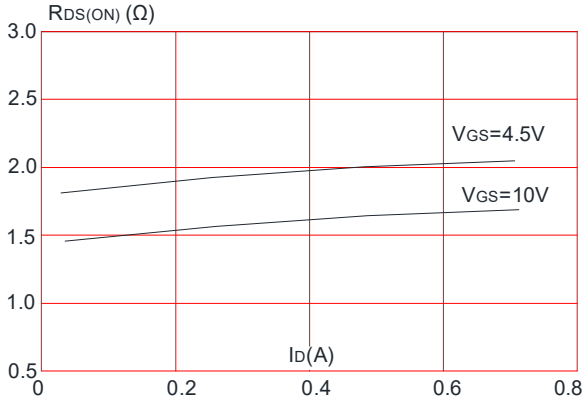

Figure 4: Body Diode Characteristics

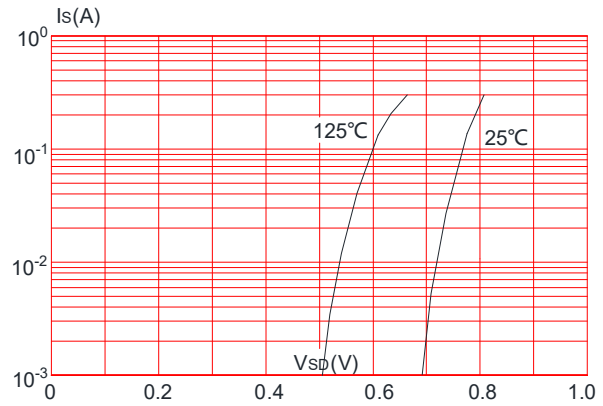

Figure 5: Gate Charge Characteristics

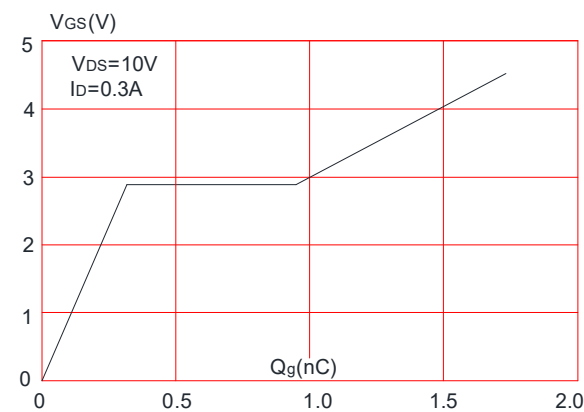
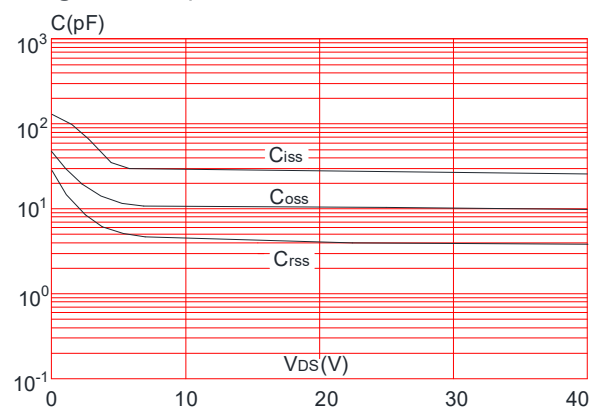

Figure 6: Capacitance Characteristics





JMTLB2N7002KDS

Figure 7: Normalized Breakdown Voltage vs. Junction Temperature

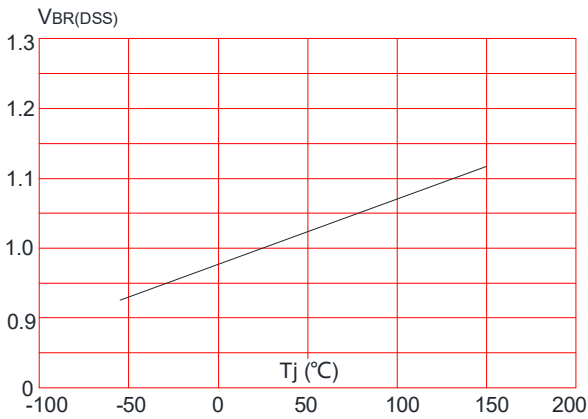

Figure 8: Normalized on Resistance vs. Junction Temperature

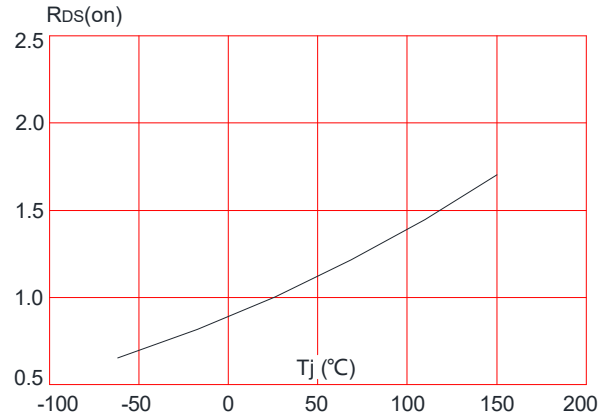

Figure 9: Maximum Safe Operating Area

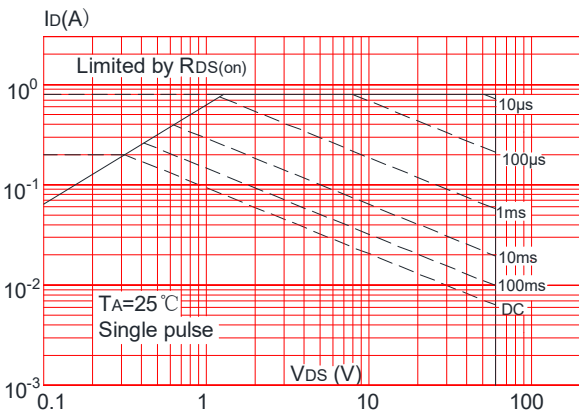

Figure 10: Maximum Continuous Drain Current vs. Ambient Temperature

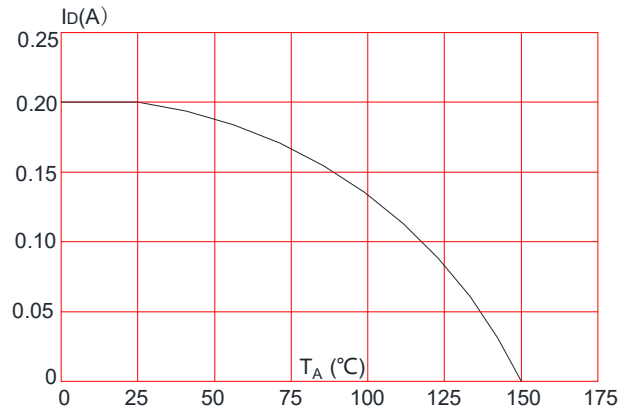
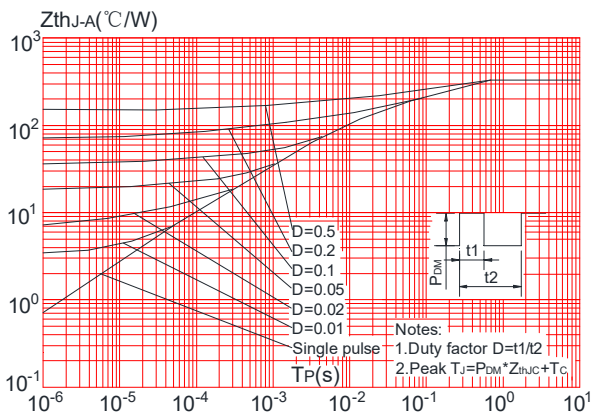

Figure.11: Maximum Effective Transient Thermal Impedance, Junction-to-Ambient



Test Circuit

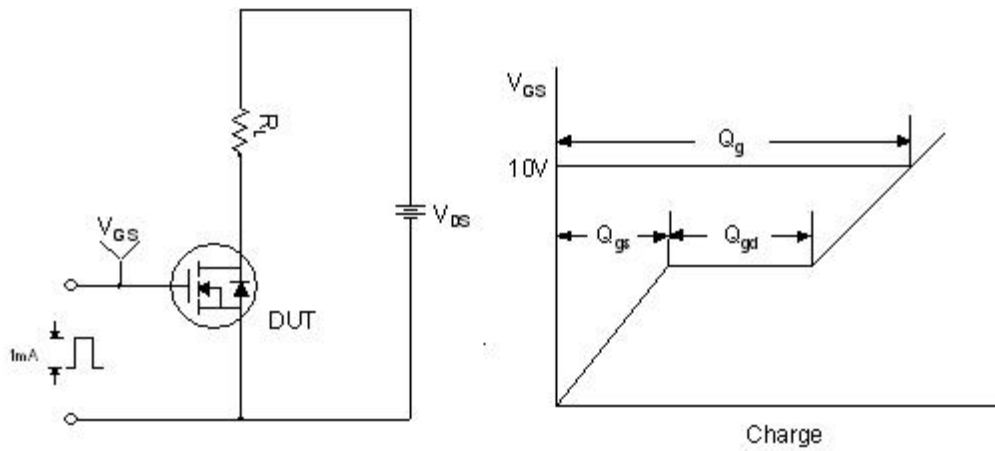

Figure 1. Gate Charge Test Circuit & Waveform

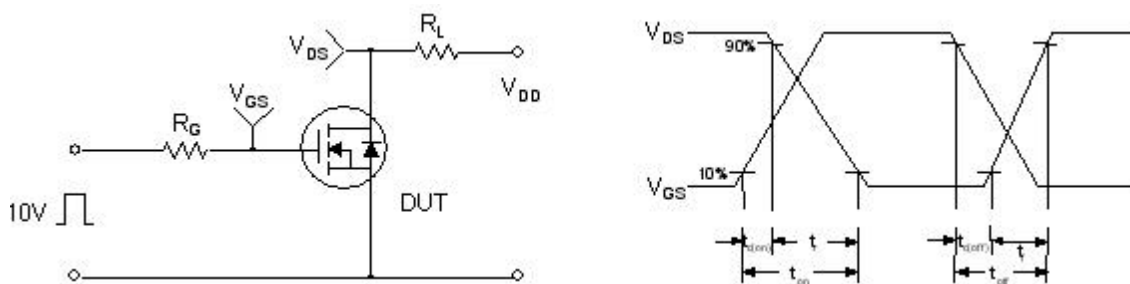

Figure 2. Resistive Switching Test Circuit & Waveforms

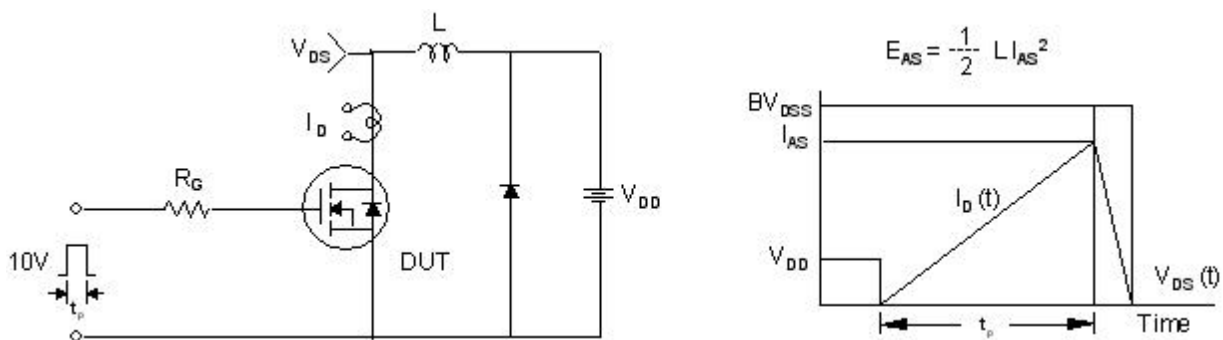
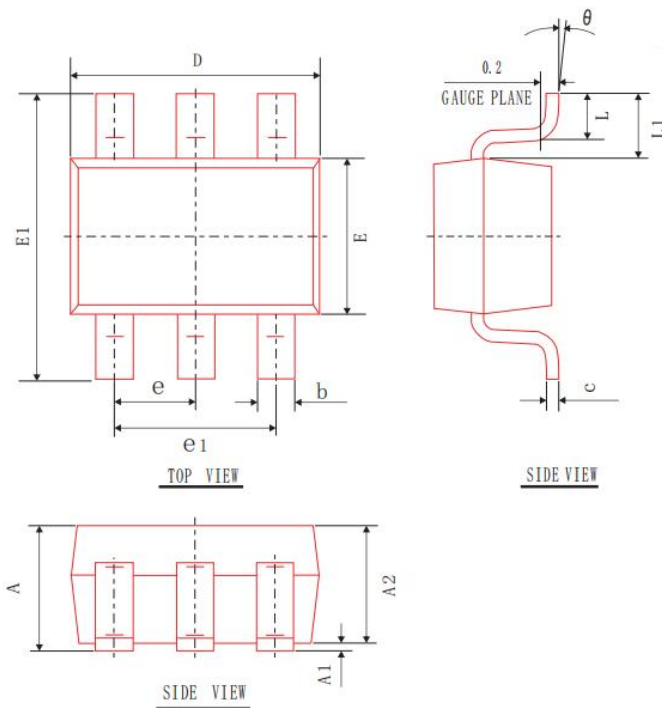

Figure 3. Unclamped Inductive Switching Test Circuit & Waveforms



Package Mechanical Data-SOT-363-6L



COMMON DIMENSIONS
(UNITS OF MEASURE=mm)

SYMBOL	MIN	NOM	MAX
A	0.90	1.00	1.10
A1	0.00	0.05	0.10
A2	0.90	0.95	1.00
b	0.20	0.25	0.30
c	0.08	0.10	0.15
e1	1.20	1.30	1.40
D	2.00	2.10	2.20
E	1.15	1.25	1.35
E1	2.15	2.30	2.45
L	0.26	0.36	0.46
θ	0°	4°	8°
L1	0.525 REF		
e	0.65 TYP		

Information furnished in this document is believed to be accurate and reliable. However, Jiangsu JieJie Microelectronics Co.,Ltd assumes no responsibility for the consequences of use without consideration for such information nor use beyond it.

Information mentioned in this document is subject to change without notice, apart from that when an agreement is signed, Jiangsu JieJie complies with the agreement.

Products and information provided in this document have no infringement of patents. Jiangsu JieJie assumes no responsibility for any infringement of other rights of third parties which may result from the use of such products and information.



is a registered trademark of Jiangsu JieJie Microelectronics Co.,Ltd.

Copyright ©2022 Jiangsu JieJie Microelectronics Co.,Ltd. Printed All rights reserved.